































...la tua azienda di fiducia!

**RICAMBI GENERICI
ANELLI TENUTA
MARMITTE
MOLLE
TRAZIONI**



**G&W**

	754 ANELLI DI TENUTA		767 MANETTINI COMANDO GAS CON CAVO
	758 CATENE DI TRASMISSIONE		768 MANETTINI COMANDO GAS
	758 BOCCOLE PER SUPPORTO PIATTI		769 GRILLETTI COMANDO GAS PER DECESPUGLIATORE
	758 MAGLIE CATENA TRASMISSIONE		769 MANICOTTI DI COLLEGAMENTO
	760 MOLLE A TAZZA		769 MANICOTTI DI RIDUZIONE
	761 BULLONI TRANCIO PER SPAZZANEVE		769 PASTIGLIE DEI FRENI
	762 CHIAVETTE		702 PROTEZIONI PER INTERRUITORI INDAK
	764 MARMITTE		769 SUPPORTI PER TRASMISSIONI
	766 COLLETTORI MARMITTE		769 RONDELLE STERZO
	766 SUPPORTI MARMITTA		770 SNODI ANGOLARI
	766 DEFLETTORI SCARICO		771 VOLANTINI A 3 LOBI
	766 DISTANZIALI		771 VOLANTINI CON BOCCOLA
	766 GHIERE DI RICAMBIO		771 VITI DI BLOCCAGGIO VOLANTE
	767 DISCHI SEMOVENZA PER SPAZZANEVE		771 VITI M8

771 VITI PER TRATTORINI

771 PIGNONI

771 ASSIEME ASTE OLIO

772 TAPPI PER VASCLETTE

772 TAPPI CAMBIO

772 SERBATOI OLIO
PER CAMBIO IDRO

772 KIT PASTIGLIE FRENO

772 VENTOLE CAMBIO

772 RICAMBI

773 PULEGGE TRAZIONE



774 TRAZIONI
PER RASAERBA

776 CARDANI







777 KIT CHIAVETTE
PER SELETTORI MARCE

777 KIT CEPPI FRENO CAMBIO

ANELLI DI TENUTA
ASIA IMPORT

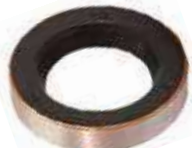
cod. Saba 1646-00050 	Ø esterno 28,2 mm	Ø interno 15 mm	spessore 4,5 mm	rif. orig. -
modello 45, 4500, 52, 5200, 58, 5800, CASTORAMA PP45, CEDRUS T4518, T5018, ECO 460-18, FAWORYT TS 520, TS 460, TS 45-18, HARDER PN4500, LIDER 46-18, NAC SPS01-45, TOPSUN T4516, 4518, T5016/50				
cod. Saba 1646-00048 	Ø esterno 35,2 mm	Ø interno 15 mm	spessore 4,5 mm	rif. orig. -
modello 45, 4500, 52, 5200, 58, 5800, CASTORAMA PP45, CEDRUS T4518, T5018, ECO 460-18, FAWORYT TS 520, TS 460, TS 45-18, HARDER PN4500, LIDER 46-18, NAC SPS01-45, TOPSUN T4516, 4518, T5016/50				

BRIGGS & STRATTON

cod. Saba 0146-01442 	Ø esterno 32 mm	Ø interno 21,4 mm	spessore 4,84 mm	rif. orig. 299819, 89660
modello 60000, 80000, 92000, 93000, 111000, 110000				
cod. Saba 0146-01441 	Ø esterno 35,1 mm	Ø interno 21,4 mm	spessore 7,07 mm	rif. orig. 391483, 291841
modello 60000, 80000, 92000, 93000, 111000, 110000, V17>V30				
cod. Saba 0146-01446 	Ø esterno 39,83 mm	Ø interno 24,06 mm	spessore 8,28 mm	rif. orig. 391485, 294167
modello Per motore verticale 5CV				
cod. Saba 0146-01448 	Ø esterno 35,15 mm	Ø interno 25,4 mm	spessore 4,45 mm	rif. orig. 294606
modello 170000, 190000 6>8 HP				
cod. Saba 2846-34011 	Ø esterno 43 mm	Ø interno 26 mm	spessore 7,9 mm	rif. orig. 399781
modello 97700, 99700, 12A800, 120800, 121700>129800, 104700				
cod. Saba 2846-34013 	Ø esterno 41,4 mm	Ø interno 25 mm	spessore 4,7 mm	rif. orig. 495307, 555087
modello Per motore orizzontale 3-5CV				

BRIGGS & STRATTON - SEGUE
cod. Saba 0146-01445

Ø esterno
43 mm

Ø interno
29,2 mm

spessore
6,26 mm

rif. orig.
391086, 298423, 690926

modello 6HP > 8 HP

cod. Saba 0146-01447

Ø esterno
47,82 mm

Ø interno
36,3 mm

spessore
8 mm

rif. orig.
291675

modello 251000, 252000, 401000, 402000, 422000=10HP, 422000=11HP, 422000=16HP, 421000

DOLMAR
cod. Saba 1846-02051

Ø esterno
28 mm

Ø interno
15,8 mm

spessore
6 mm

rif. orig.
962 900 037

modello -

HONDA
cod. Saba 1846-04747

Ø esterno
44 mm

Ø interno
30 mm

spessore
8 mm

rif. orig.
91201-889-003

modello GX240, GX270, GX300

cod. Saba 1846-04748

Ø esterno
52 mm

Ø interno
35 mm

spessore
8 mm

rif. orig.
91201-ZE3-004

modello GX340, GX390

cod. Saba 1846-04749

Ø esterno
41 mm

Ø interno
25 mm

spessore
6 mm

rif. orig.
91202-883-005

modello GX160

HUSQVARNA
cod. Saba 1846-02202

Ø esterno
18,1 mm

Ø interno
15,6 mm

spessore
5,2 mm

rif. orig.
503 26 02-05

modello 44, 181, 240, 285, 340SE, 340SG, 444, 2100

cod. Saba 1846-02201

Ø esterno
26,1 mm

Ø interno
13,7 mm

spessore
6,3 mm

rif. orig.
503 26 02-04

modello 162, 266, 480CD, 77L





G&W

ANELLI DI TENUTA

RICAMBI GENERICI, ANELLI TENUTA,
MARMITTE, MOLLE, TRAZIONI

HUSQVARNA - SEGUE

cod. Saba 1846-02353 	Ø esterno 26,2 mm	Ø interno 14,1 mm	spessore 3,1 mm	rif. orig. 505 27 57-18, 505 27 57-19
	modello 40, 45, 49, 154, 240, 245, 254, 261, 262, 343, 346, 353, 356, 357, 359, 365, 371, 590, 2041, 2045, 2050			
cod. Saba 2046-12206 	Ø esterno 26,54 mm	Ø interno 17,8 mm	spessore 3,85 mm	rif. orig. 503 26 03-01
	modello 362, 365, 371, 372, 371K			

PEERLESS

cod. Saba 0162-30402 	Ø esterno 25,58 mm	Ø interno 13,08 mm	spessore -	rif. orig. 788089A
	modello -			
cod. Saba 0162-30400 	Ø esterno 32 mm	Ø interno 19,05 mm	spessore -	rif. orig. 788097, 788088A
	modello -			

STIHL

cod. Saba 2046-12200 	Ø esterno 20,3 mm	Ø interno 11,5 mm	spessore 4,8 mm	rif. orig. 9640 003 1190
	modello 020, 024, 026, 034, MS360, FS220, MS280			
cod. Saba 2046-12202 	Ø esterno 20,3 mm	Ø interno 12,5 mm	spessore 4,1 mm	rif. orig. 9640 003 1355
	modello 046, 064, 066, MS460, MS640			
cod. Saba 2046-12225 	Ø esterno 22 mm	Ø interno 12 mm	spessore 5 mm	rif. orig. 9640 003 1195
	modello FS400, FS450, FS480			
cod. Saba 2046-12205 	Ø esterno 25 mm	Ø interno 12 mm	spessore 5 mm	rif. orig. 9639 003 1585
	modello MS170, MS180, MS210, MS230, MS250, MS270, MS280			

STIHL - SEGUE

cod. Saba 2046-12201 	Ø esterno 29,7 mm	Ø interno 15 mm	spessore 4 mm	rif. orig. 9640 003 1600
modello 024, 026, 028, 034, FS360, FS420, FS500, FS550				
cod. Saba 2046-12203 	Ø esterno 33 mm	Ø interno 15,9 mm	spessore 3 mm	rif. orig. 9640 003 1850
modello 066, 064, MS640, MS650, MS660				
cod. Saba 2046-12204 	Ø esterno 30 mm	Ø interno 17 mm	spessore 4,5 mm	rif. orig. 9639 010 1743
modello MS290, MS310, MS390				

TECUMSEH

cod. Saba 0146-01441 	Ø esterno 35,1 mm	Ø interno 21,4 mm	spessore 7,07 mm	rif. orig. 391483, 291841
modello 60000, 80000, 92000, 93000, 111000, 110000, V17 > V30				
cod. Saba 0146-02714 	Ø esterno 35,8 mm	Ø interno 20,6 mm	spessore 6,6 mm	rif. orig. 26208, 7608, 29610001, TC26208
modello LAV30, LAV35, TVS75, TVS90, ECV100, TNT100				
cod. Saba 0146-02715 	Ø esterno 38,2 mm	Ø interno 25,4 mm	spessore 6,3 mm	rif. orig. 29610018
modello LAV40, LAV50, HS40, HS50, TVS10, TNT120, V50, V60, V70, VH60, VH70				

UNIVERSALE

cod. Saba 0162-20010 	Ø esterno 22 mm	Ø interno 12 mm	spessore -	rif. orig. -
modello -				
cod. Saba 0162-20012 	Ø esterno 30 mm	Ø interno 15 mm	spessore -	rif. orig. -
modello -				



G&W

RICAMBI GENERICI, ANELLI TENUTA,
MARMITTE, MOLLE, TRAZIONI



CATENE DI TRASMISSIONE

cod. Saba 0141-00386

lunghezza mt	3
Ø rullo mm	7,6
larghezza mm	6,4
dist. passo mm	12,7
tipo	C-41
largh. int. mm	-



cod. Saba 0141-00392

lunghezza mt	3
Ø rullo mm	7,7
larghezza mm	13,4
dist. passo mm	12,7
tipo	420
largh. int. mm	9,65



BOCCOLE PER SUPPORTO PIATTI

GRASSHOPPER **cod. Saba 0135-20010**

rif. orig.	282575
foro mm	9,5



MAGLIE CATENA TRASMISSIONE

cod. Saba 0141-00400 ☒

passo	9,54
larghezza mm	5,7



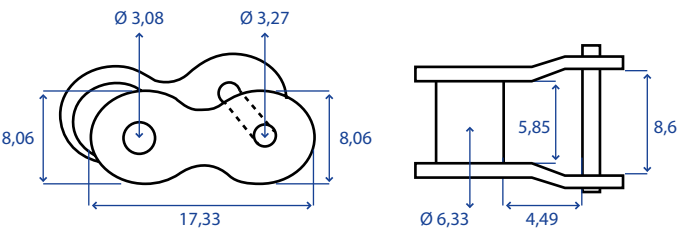

cod. Saba 0141-00412 ☒

passo	9,54
larghezza mm	4,76

cod. Saba 1041-00400

passo	9,54
larghezza mm	5,72

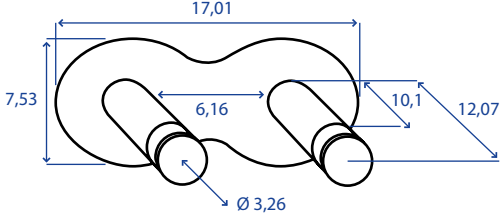
cod. Saba **1041-00403**

passo 12,7
larghezza mm 4,88

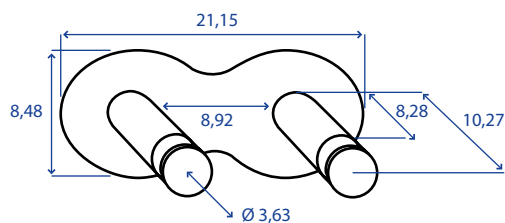

cod. Saba **1041-00404** ☒

passo 12,7
larghezza mm 3,17

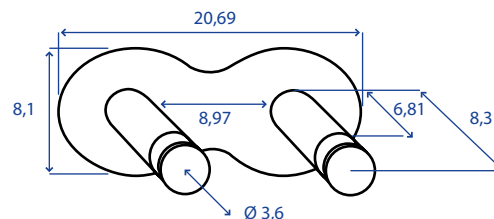

cod. Saba **1041-00402** ☒

passo 12,7
larghezza mm 6,35

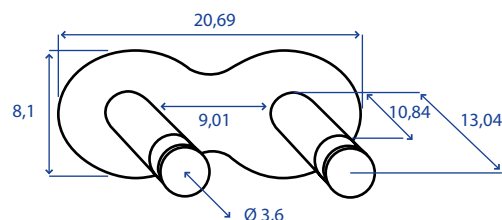

cod. Saba **1041-00416** ☒

passo 12,7
larghezza mm 3,17
TYP 43

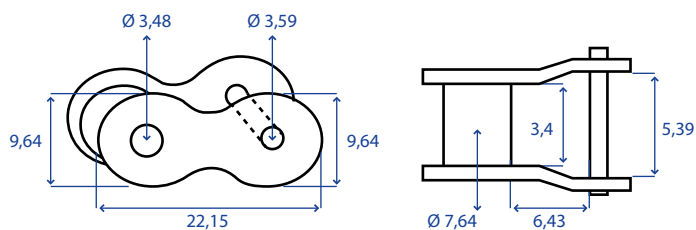

cod. Saba **1041-00420** ☒

passo 12,7
larghezza mm 6,35
TYP 420

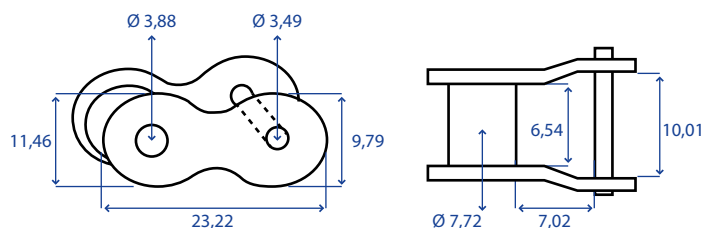

cod. Saba **1041-00408** ☒

passo 12,7
larghezza mm 6,35

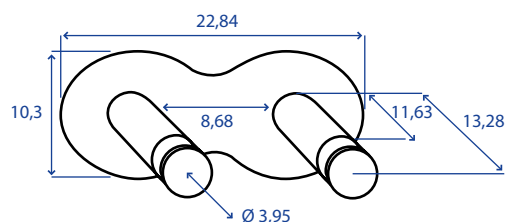



G&W



cod. Saba **0141-00401** ☒

passo 12,7
larghezza mm 7,93

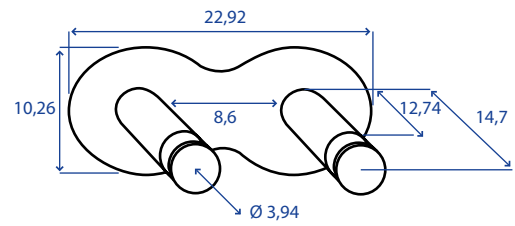

cod. Saba **0141-00409**

passo 12,7
larghezza mm 7,93

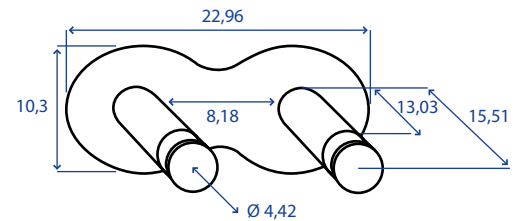

cod. Saba **0141-00405** ☒

passo 15,87
larghezza mm 9,54

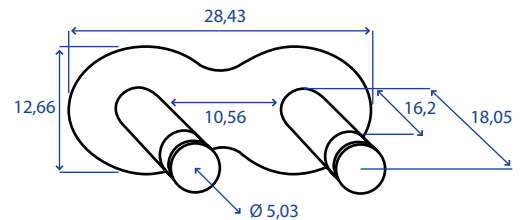

cod. Saba **0141-00406**

passo 19,05
larghezza mm 12,7

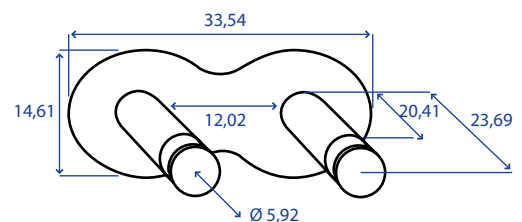

MOLLE A TAZZA



cod. Saba	Ø esterno	Ø interno	☒
0106-01187	38,17 mm	11,6 mm	☒
0106-01188	57,1 mm	9,5 mm	☒

cod. Saba	Ø esterno	Ø interno	☒
0106-01189	57,1 mm	12,7 mm	☒
0106-01190	76 mm	9,5 mm	☒

BULLONI TRANCIO PER SPAZZANEVE
ARIENS

cod. Saba 0106-00916 	<input checked="" type="checkbox"/>	lunghezza 54 mm modello ST420, ST520, ST8526L, ST11270HV, ST1332OHV	filetto 5/16"	rif. orig. 51001500
cod. Saba 0106-00917 	<input checked="" type="checkbox"/>	lunghezza 44 mm modello -	filetto 1/4"	rif. orig. 51001500
cod. Saba 0106-00918 	<input checked="" type="checkbox"/>	lunghezza 40 mm modello ST270, ST350, ST420, ST504, ST3520, ST724, ST524, ST824L	filetto 1/4"	rif. orig. 51001600

AXXOM

cod. Saba 2306-53114 		lunghezza - modello -	filetto -	rif. orig. 281490
--	--	---	---------------------	-----------------------------

AYP

cod. Saba 2306-22495 	<input checked="" type="checkbox"/>	lunghezza - modello -	filetto -	rif. orig. 535 41 09-01
cod. Saba 2306-22496 	<input checked="" type="checkbox"/>	lunghezza - modello -	filetto -	rif. orig. 506 96 62-01

HONDA

cod. Saba 0106-05540 	<input checked="" type="checkbox"/>	lunghezza 48,8 mm modello -	filetto M6 x 1	rif. orig. 90102-732-010, 90114-SA0-000
--	-------------------------------------	---	--------------------------	---

HUSQVARNA

cod. Saba 0106-05541 	<input checked="" type="checkbox"/>	lunghezza 47,8 mm modello -	filetto -	rif. orig. 506 69 00-01, 506 71 40-01, 531 00 25-13
cod. Saba 2306-22495 	<input checked="" type="checkbox"/>	lunghezza - modello -	filetto -	rif. orig. 535 41 09-01
cod. Saba 2306-22496 	<input checked="" type="checkbox"/>	lunghezza - modello -	filetto -	rif. orig. 506 96 62-01

KARSIT

cod. Saba 2306-53114 		lunghezza - modello -	filetto -	rif. orig. 281490
--	--	---	---------------------	-----------------------------





G&W

BULLONI TRANCIO PER SPAZZANEVE

RICAMBI GENERICI, ANELLI TENUTA,
MARMITTE, MOLLE, TRAZIONI

MTD

cod. Saba 0106-05549 	☒	lunghezza	filetto	rif. orig. 738-04124A
		41,5 mm	1/4"	
modello 380D, 611D, E640F, E740F, E660G				
cod. Saba 0106-08628 	☒	lunghezza	filetto	rif. orig. 710-0891
		44,5 mm	5/16"	
modello E993 I, E980 I, 353, N10-84L, 12-33, HDS6284				

SNAPPER

cod. Saba 0106-00916 	☒	lunghezza	filetto	rif. orig. 51001500
		54 mm	5/16"	
modello 1-3865				

STIGA

cod. Saba 0106-00916 	☒	lunghezza	filetto	rif. orig. 51001500
		54 mm	5/16"	
modello 828, 1030, 1232				

YARDMAN



cod. Saba 0106-05549 	☒	lunghezza	filetto	rif. orig. 738-04124A
		41,5 mm	1/4"	
modello 5655DE, 6170DE, 7195DE				
cod. Saba 0106-08628 	☒	lunghezza	filetto	rif. orig. 710-0891
		44,5 mm	5/16"	
modello 5655DE, 6170DE, 7195DE				

CHIAVETTE

ALKO

cod. Saba 0105-01595 	☒	lunghezza	larghezza	spessore	rif. orig. 701595
		20 mm	8 mm	7 mm	
modello T13-82HD, T13-85SD, T13-102, T14-102SD, T15-92, T16-102, T18-102, T1000HD, T165-102HD, T850					

BRIGGS & STRATTON

cod. Saba 1115-45064 	☒	lunghezza	larghezza	spessore	rif. orig. 222698
		14 mm	3,6 mm	4,6 mm	
modello -					
cod. Saba 0115-01435 	☒	lunghezza	larghezza	spessore	rif. orig. 61760
		14,8 mm	4 mm	-	
modello -					

CASTEL GARDEN

cod. Saba 2805-02599 	☒	lunghezza	larghezza	spessore	rif. orig. 12139100/0
		15 mm	-	4 mm	
modello -					

CASTEL GARDEN - SEGUE
cod. Saba 2305-17976

lunghezza
20 mm

larghezza
-

spessore
6 x 6 mm

rif. orig.
12139480/0

modello -

STIGA
cod. Saba 0105-50204

lunghezza
-

larghezza
-

spessore
-

rif. orig.
1134-0323-00

modello -

TECUMSEH
cod. Saba 2815-17260

lunghezza
20 mm

larghezza
6,15 mm

spessore
5,5 mm

rif. orig.
29410011

modello -

cod. Saba 2815-17261

lunghezza
20,4 mm

larghezza
3,15 mm

spessore
5,5 mm

rif. orig.
29410012, 610995

modello BVL, BVS, BV, ELECTRONIC

cod. Saba 0115-01437

lunghezza
25,4 mm

larghezza
3,22 mm

spessore
4,8 mm

rif. orig.
27902

modello -

UNIVERSALE

1

2

cod. Saba	lunghezza	larghezza	spessore	fig.	<input type="checkbox"/>
0115-05600	300 mm	4,76 mm	4,76 mm	1	<input type="checkbox"/>
0115-05601	300 mm	6,35 mm	6,35 mm	1	<input type="checkbox"/>
0115-06000	300 mm	9,52 mm	9,52 mm	1	<input type="checkbox"/>
3058-02411	2"	3/16"	3/16"	1	<input checked="" type="checkbox"/>
0158-00034	9,54 mm	-	2,38 mm	2	<input type="checkbox"/>
0158-00035	9,54 mm	-	3,17 mm	2	<input checked="" type="checkbox"/>
0158-00036	12,70 mm	-	1,59 mm	2	<input checked="" type="checkbox"/>
0158-00038	12,70 mm	-	3,17 mm	2	<input checked="" type="checkbox"/>
0158-00041	15,87 mm	-	3,97 mm	2	<input checked="" type="checkbox"/>
0158-00043	19,05 mm	-	3,97 mm	2	<input type="checkbox"/>
0158-00048	15,87 mm	-	4,76 mm	2	<input type="checkbox"/>

MARMITTE

ASIA IMPORT rif. orig. 1E34F modello 26 cc 	cod. Saba 0109-00706	ASIA IMPORT rif. orig. 1E36F modello 34 cc 	cod. Saba 0109-00700
ASIA IMPORT rif. orig. - modello 38 cc, 41 cc 	cod. Saba 0109-00710	ASIA IMPORT rif. orig. 1E40F modello 45 cc, 52 cc 	cod. Saba 0109-00702
ASIA IMPORT rif. orig. - modello 45 cc, 52 cc, 58 cc 	cod. Saba 0109-00704	ASPERA rif. orig. 33697A, 32648A modello H40, H50, H60, H70, HS50, LAV50, TVS120, TVS75, TVS90, TVS105, TVXL SERIES 	cod. Saba 0109-02284
BRIGGS & STRATTON rif. orig. 393615 modello 5HP 	cod. Saba 0109-00892	BRIGGS & STRATTON rif. orig. 391313, 291313 modello 5HP, 7HP, 8HP 	cod. Saba 0109-01283
BRIGGS & STRATTON rif. orig. 393760 modello 5HP, Series 130200 > 130299 	cod. Saba 0109-08004	BRIGGS & STRATTON rif. orig. 299477, 391569, 393232 lunghezza 286 mm Ø 31,75 mm filetto 31,75 mm 	cod. Saba 0109-00859
BRIGGS & STRATTON rif. orig. 490547, 496106, 692038 modello 4,5, 5 HP QUANTUM 	cod. Saba 0109-07867	BRIGGS & STRATTON rif. orig. 491413, 394170, 394180 modello - 	cod. Saba 0109-08003
BRIGGS & STRATTON rif. orig. 298830, 394569 attacco 20 filetto 1/2" 	cod. Saba 0109-01272	BRIGGS & STRATTON rif. orig. 294599, 291244, 395011 Ø 26 mm filetto 3/4" 	cod. Saba 0109-01275
HONDA rif. orig. 18310-ZF1-000 modello GX110, GX120, GX140, GX160 	cod. Saba 2809-01117	HONDA rif. orig. 18310-ZE2-W00 , 18320-ZE2-W01, 18310-ZE2-01 modello GX240, GX270 	cod. Saba 6209-00394
HONDA rif. orig. 18310 ZE2 W61 modello GX340, GX390 	cod. Saba 6209-00390	HUSQVARNA rif. orig. 503 59 92-05, 503 40 64-02 modello 268, 272 	cod. Saba 3009-01038

HUSQVARNA rif. orig. 503 87 96-02 modello 340, 345, 350	cod. Saba 5209-34530 	HUSQVARNA rif. orig. 503 91 76-01 modello 355, 357, 359	cod. Saba 3009-01083
HUSQVARNA rif. orig. 530 06 94-15 modello 36, 136, 137, 141, 142	cod. Saba 1909-19304 	HUSQVARNA rif. orig. 503 76 53-01 modello 365, 371, 372	cod. Saba 3009-01039
HUSQVARNA rif. orig. 501 76 66-02 modello 51, 55	cod. Saba 5209-05130 	JONSERED rif. orig. 503 87 96-02 modello 2141, 2145, 2149	cod. Saba 5209-34530
JONSERED rif. orig. 503 91 76-01 modello 2156, 2159	cod. Saba 3009-01083 	KOHLER rif. orig. 237550 modello 7HP, 10HP, 12HP	cod. Saba 0109-08284
STIHL rif. orig. 1135 140 0653 modello MS361	cod. Saba 1909-19813 	STIHL rif. orig. 1122 140 0614 modello 066 MS660	cod. Saba 3009-01035
STIHL rif. orig. 1123 140 0604 modello 021, 023, 025, MS210, MS230, MS250	cod. Saba 5209-02330 	STIHL rif. orig. 1121 140 0604 modello 024, 026	cod. Saba 3009-01031
STIHL rif. orig. 1128 140 0600 modello 046, MS460	cod. Saba 3009-01034 	STIHL rif. orig. 1127 140 0601 modello 029, 039, 034, 036, MS290, MS310, MS390	cod. Saba 3009-32652
STIHL rif. orig. 1125 140 0607 modello 034, 036, MS340, MS360	cod. Saba 3009-01033 	STIHL rif. orig. 1119 007 1005 modello 038	cod. Saba 3009-01032
STIHL rif. orig. 4223 140 0660, 4223 140 0601 modello TS40	cod. Saba 3009-09805 	TECNAMOTOR rif. orig. 33697A, 32648A modello H40, H50, H60, H70, H550, LAV50, TVS120, TVS75, TVS90, TVS105, TVXL SERIES	cod. Saba 0109-02284

**G&W****MARMITTE****RICAMBI GENERICI, ANELLI TENUTA,
MARMITTE, MOLLE, TRAZIONI****TECUMSEH**cod. Saba **0109-02284**rif. orig. 33697A, 32648A
modello H40, H50, H60,
H70, HS50, LAV50, TVS120,
TVS75, TVS90, TVS105,
TVXL SERIES**TECUMSEH**cod. Saba **0109-01277**rif. orig. 32043A/B,
275679, 392989
modello 8/16 CV
filetto 1 1/4"
Ø int. 31,75**COLLETTORI MARMITTE****HONDA**cod. Saba **2019-50000**rif. orig. 18300 ZE2 W00
modello GX 240, GX 270,
GX 340, GX 390**MURRAY**cod. Saba **2019-50100**rif. orig. 1401357MAC
modello INTEK OHV**UNIVERSALE**cod. Saba **2019-00000**rif. orig. 382640001/1
modello TC102, TC122**SUPPORTI MARMITTA****HUSQVARNA**cod. Saba **5209-35933**rif. orig. 503 91 74-01
modello 359**DEFLETTORI SCARICO****HONDA**cod. Saba **1109-10414**modello GX240,
GX270,
GX340,
GX390,
GXV390**DISTANZIALI****GRASSHOPPER**cod. Saba **0135-20004**rif. orig. 942137
lunghezza mm 62
Ø est. mm 15,8
Ø int. mm 9,5**GRASSHOPPER**cod. Saba **0135-20006**rif. orig. 902284
lunghezza mm 52
Ø est. mm 15,8
Ø int. mm 9,5**GHIERE DI RICAMBIO**-
applicazione 0114-09654cod. Saba **3014-06002**













DISCHI SEMOVENZA PER SPAZZANEVE

ARIENS rif. orig. 22013 modello - Ø est. mm 111 Ø int. mm 57	cod. Saba 3037-07846 	ASIA IMPORT rif. orig. 735-0243, 735-243B modello 611 Ø est. mm 123,8 Ø int. mm 101,6	cod. Saba 3037-40991 
MTD rif. orig. 718-0494 modello E-993 I Ø est. mm 150 Ø int. mm 41,3	cod. Saba 3037-07855 	MTD rif. orig. 05080A modello 500, 510, 520, 600 Ø est. mm 152 Ø int. mm 28,5	cod. Saba 0137-08898 
MTD rif. orig. 735-0243, 735-243B modello 611 Ø est. mm 123,8 Ø int. mm 101,6	cod. Saba 3037-40991 	MURRAY rif. orig. 313883 modello - Ø est. mm 111 Ø int. mm 57	cod. Saba 3037-07846 
MURRAY rif. orig. 7017226, 376570 Ø est. mm 111 Ø int. mm 25,4	cod. Saba 0137-07678 	NOMA rif. orig. 9005383 modello - Ø est. mm 111 Ø int. mm 57	cod. Saba 3037-07846 
SNAPPER rif. orig. 10765, 3510765 modello AGGIUNGERE 0137-00345 Ø est. mm 152,5 Ø int. mm 76,3	cod. Saba 0137-00300 	STIGA rif. orig. 10765, 3510765 1812-9003-01 modello - Ø est. mm 152,5 Ø int. mm 76,3	cod. Saba 0137-00300 
TORO rif. orig. 40-8170 modello - Ø est. mm 152,4 Ø int. mm 44,4	cod. Saba 3037-09842 	YARDMAN rif. orig. 718-0494 modello 31AE993I643 Ø est. mm 150 Ø int. mm 41,3	cod. Saba 3037-07855 

MANETTINI COMANDO GAS CON CAVO

UNIVERSALE lunghezza mt 1,25 nota con cavo	cod. Saba 1425-00003 	UNIVERSALE lunghezza mt 1,55 nota con cavo	cod. Saba 1425-00004 
--	--	--	--

MANETTINI COMANDO GAS

GGP descrizione Per rasaerba in plastica	cod. Saba 3027-07144 	MTD rif. orig. 54311-VE0-J50 modello HRD536	cod. Saba 3027-04311 
MTD descrizione Per rasaerba in plastica	cod. Saba 3027-07160 	UNIVERSALE lunghezza cm 9 tipo -	cod. Saba 0127-07905 
UNIVERSALE lunghezza cm 11,5 tipo -	cod. Saba 0127-07906 	UNIVERSALE lunghezza cavo mm 1400	cod. Saba 1127-95089 
UNIVERSALE lunghezza cm - tipo 1/2"	cod. Saba 3027-07132 	UNIVERSALE lunghezza cm - tipo 1/2"	cod. Saba 3027-07133 
UNIVERSALE lunghezza cm - tipo 1/2"	cod. Saba 3027-07134 	UNIVERSALE lunghezza cm - tipo 3/4"	cod. Saba 3027-07138 
UNIVERSALE lunghezza cm - tipo 3/4"	cod. Saba 3027-07139 	UNIVERSALE lunghezza cm - tipo professionale	cod. Saba 3027-07142 
UNIVERSALE lunghezza cm - tipo carenato	cod. Saba 3027-07146 		

GRILLETTI COMANDO GAS PER DECESPUGLIATORE

ASIA IMPORT	cod. Saba 1963-32400
rif. orig. - modello 25 cc	

ASIA IMPORT	cod. Saba 1963-32402
rif. orig. - modello 38 cc	

ASIA IMPORT	cod. Saba 1963-32404
rif. orig. - modello 45 cc, 52 cc	



MANICOTTI DI COLLEGAMENTO

BRIGGS & STRATTON	cod. Saba 0120-14299
rif. orig. 692189	

MANICOTTI DI RIDUZIONE

-	cod. Saba 0135-00330
Ø est. mm 12,7 Ø int. mm 9,52 lunghezza mm 57,15	

-	cod. Saba 0135-00331
Ø est. mm 12,7 Ø int. mm 11,11 lunghezza mm 57,15	

PASTIGLIE DEI FRENI

SNAPPER	cod. Saba 0137-00345
rif. orig. 57423 applicazione 0137-00300	

PROTEZIONI PER INTERRUTTORI INDAK

-	cod. Saba 3014-06000
	

SUPPORTI PER TRASMISSIONI

GRASSHOPPER	cod. Saba 204.05.02
rif. orig. 122043, 122044 Ø int. mm 25,4	

RONDELLE STERZO

MTD	cod. Saba 0137-13229
rif. orig. 941-0656A, 741-0656	

SNODI ANGOLARI

ALKO rif. orig. 514701 modello T 9-75 > T 20-102 filettatura int. - filettatura est. M10	cod. Saba 0136-14001 	ALKO rif. orig. 514239 modello T13-85HD, T15-102HD, T16-102, T17-102HD, T18-102HD, T20-102HD filettatura int. - filettatura est. -	cod. Saba 3036-17301 
CASTEL GARDEN rif. orig. 22746600/0 modello M10 filettatura int. M10 filettatura est. M10	cod. Saba 0136-00534 	CASTEL GARDEN rif. orig. 22746601/0, 22746602/0 modello M8 filettatura int. M8 filettatura est. M8	cod. Saba 0136-00535 
GRASSHOPPER rif. orig. 265616 modello 5/16" 24 UNF filettatura int. - filettatura est. -	cod. Saba 0136-14100 	HUSQVARNA rif. orig. 109851X modello - filettatura int. 3/8" = 24 filettatura est. 3/8" = 24	cod. Saba 0136-09489 
MTD rif. orig. 923-0448, 723-0448, 112-0917 modello - filettatura int. 7/16" = 20 filettatura est. 3/8" = 24	cod. Saba 0136-09159 	MTD rif. orig. 923-0351 modello - filettatura int. 3/8" = 24 filettatura est. 3/8" = 24	cod. Saba 0136-09489 
TORO rif. orig. 923-0448, 723-0448, 112-0917 modello - filettatura int. 7/16" = 20 filettatura est. 3/8" = 24	cod. Saba 0136-09159 	UNIVERSALE rif. orig. - modello - filettatura int. 1/4" = 28G filettatura est. 1/4" = 28G	cod. Saba 0136-02208 
UNIVERSALE rif. orig. - modello - filettatura int. 1/4" = 28G filettatura est. 1/4" = 28G	cod. Saba 0136-02209 	UNIVERSALE rif. orig. - modello - filettatura int. 3/8" = 24G filettatura est. 3/8" = 24G	cod. Saba 0136-02210 
UNIVERSALE rif. orig. - modello - filettatura int. 7/16" filettatura est. 7/16"	cod. Saba 0136-02219 	UNIVERSALE rif. orig. - modello - filettatura int. 7/16" filettatura est. 3/8"	cod. Saba 0136-02222 
UNIVERSALE rif. orig. - modello - filettatura int. 3/8" filettatura est. 3/8"	cod. Saba 0136-02225 	UNIVERSALE rif. orig. - modello - filettatura int. 3/8" = 24 filettatura est. 3/8" = 24	cod. Saba 0136-09489 
UNIVERSALE rif. orig. - modello - filettatura int. 5/16" = 24 filettatura est. 5/16" = 24	cod. Saba 0136-13451 	UNIVERSALE rif. orig. - modello - filettatura int. 1/2" - 20G filettatura est. 1/2" - 20G	cod. Saba 0136-02212 

UNIVERSALE	cod. Saba 0136-02211	
rif. orig.	-	
modello	-	
filettatura int.	7/16" - 20G	
filettatura est.	1/4" - 20G	

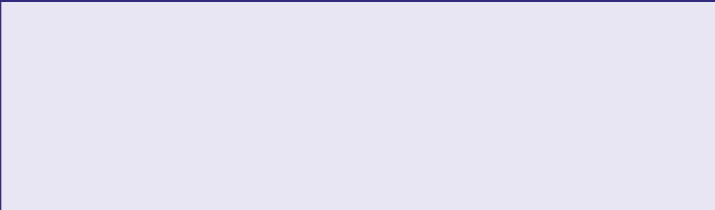

VOLANTINI A 3 LOBI	
HONDA	cod. Saba 2831-01510
rif. orig.	90109-VA4-000, 53125-VA5-000
filetto	M8
	

VOLANTINI CON BOCCOLA	
UNIVERSALE	cod. Saba 0127-20000
filetto	M8
	

VITI DI BLOCCAGGIO VOLANTE			
-	cod. Saba 2831-11235	-	cod. Saba 0131-00863
Ø mm	8	Ø mm	8
filetto	M8	filetto	M8
			

VITI M8			
HONDA	cod. Saba 0127-20006	UNIVERSALE	cod. Saba 0127-20002
applicazione	-	applicazione	0127-20000
filetto	M8	filetto	M8
			

VITI PER TRATTORINI	
UNIVERSALE	cod. Saba 0606-01208-10 
rif. orig.	000.02.336
lunghezza mm	75
filetto	3/8" UNF
adattabile	MTD
	

PIGNONI	
PEERLESS	cod. Saba 0162-30300
rif. orig.	786049
denti	8
	

ASSIEME ASTE OLIO			
LONCIN	cod. Saba 1921-19200	LONCIN	cod. Saba 1921-19202
modello	140, 159, 196	modello	413, 432, 452
			



G&W

RICAMBI GENERICI, ANELLI TENUTA,
MARMITTE, MOLLE, TRAZIONI



TAPPI PER VASCLETTE

TUFF TORQ

cod. Saba **0162-30102**



TAPPI CAMBIO

TUFF TORQ

cod. Saba **0162-30100**

rif. orig. 1139-1275-01



SERBATOI OLIO PER CAMBIO IDRO

TUFF TORQ

cod. Saba **0162-30150**



KIT PASTIGLIE FRENO

PEERLESS

cod. Saba **0162-30550**

rif. orig. 799021



VENTOLE CAMBIO

GEAR

cod. Saba **0162-30200**

rif. orig. 53822



HYDRO

cod. Saba **0162-30200**

rif. orig. 53822



TUFF TORQ

cod. Saba **0162-30050**

rif. orig. -



RICAMBI

PEERLESS

cod. Saba **0162-30350**

rif. orig. 780105A
applicazione -
note boccia albero
primario /
secondario



PEERLESS

cod. Saba **0162-30600**

rif. orig. 792041
applicazione -
lunghezza 99,5 mm
note vite
differenziale



PEERLESS

cod. Saba **0162-30650**

rif. orig. 792042
applicazione 0162-30600



PULEGGE TRAZIONE

UNIVERSALE

cod. Saba **0162-20000**

rif. orig. -
Ø mm 54
foro mm 12



UNIVERSALE

cod. Saba **0162-20002**

rif. orig. -
Ø mm 60
foro mm 12



UNIVERSALE

cod. Saba **0162-20004**

rif. orig. -
Ø mm 70
foro mm 12



TRAZIONI PER RASAERBA

ALKO rif. orig. 529007 modello 47 CONFORT lunghezza tot. 450 Ø puleggia 60 lungh. lato corto 96 lungh. lato lungo 260	cod. Saba 0162-00000 	ALKO rif. orig. 549585 modello HR 5000 lunghezza tot. 507 Ø puleggia 55 lungh. lato corto 107 lungh. lato lungo 312	cod. Saba 0162-00002 
AYP rif. orig. 180184, 176293 modello 21" lunghezza tot. 470 Ø puleggia - lungh. lato corto 80 lungh. lato lungo 300	cod. Saba 0162-00050 	AYP rif. orig. 531213047 modello 546 lunghezza tot. 505 Ø puleggia 54 lungh. lato corto 87 lungh. lato lungo 330	cod. Saba 0162-00052 
AYP rif. orig. 504541403 modello - lunghezza tot. 510 Ø puleggia 80 lungh. lato corto 78 lungh. lato lungo 328	cod. Saba 0162-00054 	AYP rif. orig. 504541402 modello - lunghezza tot. 510 Ø puleggia 80 lungh. lato corto 78 lungh. lato lungo 328	cod. Saba 0162-00056 
AYP rif. orig. 531212711 modello 653 lunghezza tot. 562 Ø puleggia 54 lungh. lato corto 160 lungh. lato lungo 315	cod. Saba 0162-00060 	BLUE BIRD rif. orig. 1807400 modello TAURUS 46T lunghezza tot. 490 Ø puleggia 70 lungh. lato corto 98 lungh. lato lungo 287	cod. Saba 0162-00100 
BLUE BIRD rif. orig. 2021000 modello TAURUS 51T lunghezza tot. 490 Ø puleggia 67 lungh. lato corto 110 lungh. lato lungo 275	cod. Saba 0162-00102 	EMAK rif. orig. 8202162 modello - lunghezza tot. 470 Ø puleggia 57 lungh. lato corto 100 lungh. lato lungo 282	cod. Saba 0162-00150 
EMAK rif. orig. 66060360 modello AR48, AR53, AR MAX 53 lunghezza tot. 497 Ø puleggia 57 lungh. lato corto 100 lungh. lato lungo 305	cod. Saba 0162-00152 	EMAK rif. orig. 8203072 modello MR55 lunghezza tot. 522 Ø puleggia 57 lungh. lato corto 110 lungh. lato lungo 325	cod. Saba 0162-00154 

HARRY		cod. Saba 0162-00200
rif. orig.	-	
modello	C49	
lunghezza tot.	456	
Ø puleggia	70	
lung. lato corto	90	
lung. lato lungo	279	

HARRY		cod. Saba 0162-00202
rif. orig.	-	
modello	401	
lunghezza tot.	460	
Ø puleggia	70	
lung. lato corto	87	
lung. lato lungo	287	

HARRY		cod. Saba 0162-00204
rif. orig.	-	
modello	424	
lunghezza tot.	540	
Ø puleggia	57	
lung. lato corto	108	
lung. lato lungo	46	

HUSQVARNA		cod. Saba 0162-00050
rif. orig.	180184, 176293	
modello	21"	
lunghezza tot.	470	
Ø puleggia	-	
lung. lato corto	80	
lung. lato lungo	300	

HUSQVARNA		cod. Saba 0162-00052
rif. orig.	531 21 30-47	
modello	546	
lunghezza tot.	505	
Ø puleggia	54	
lung. lato corto	87	
lung. lato lungo	330	

HUSQVARNA		cod. Saba 0162-00054
rif. orig.	504 54 14-03	
modello	-	
lunghezza tot.	510	
Ø puleggia	80	
lung. lato corto	78	
lung. lato lungo	328	

HUSQVARNA		cod. Saba 0162-00056
rif. orig.	504 54 14-02	
modello	-	
lunghezza tot.	510	
Ø puleggia	80	
lung. lato corto	78	
lung. lato lungo	328	

HUSQVARNA		cod. Saba 0162-00060
rif. orig.	531 21 27-11	
modello	653	
lunghezza tot.	562	
Ø puleggia	54	
lung. lato corto	160	
lung. lato lungo	315	

MARAZZINI		cod. Saba 0162-00050
rif. orig.	180184, 176293	
modello	21"	
lunghezza tot.	470	
Ø puleggia	-	
lung. lato corto	80	
lung. lato lungo	300	

MARAZZINI		cod. Saba 0162-00052
rif. orig.	531213047	
modello	546	
lunghezza tot.	505	
Ø puleggia	54	
lung. lato corto	87	
lung. lato lungo	330	

MARAZZINI		cod. Saba 0162-00054
rif. orig.	504541403	
modello	-	
lunghezza tot.	510	
Ø puleggia	80	
lung. lato corto	78	
lung. lato lungo	328	

MARAZZINI		cod. Saba 0162-00056
rif. orig.	504541402	
modello	-	
lunghezza tot.	510	
Ø puleggia	80	
lung. lato corto	78	
lung. lato lungo	328	

**G&W****TRAZIONI PER RASAERBA****RICAMBI GENERICI, ANELLI TENUTA,
MARMITTE, MOLLE, TRAZIONI**

MARAZZINI		cod. Saba 0162-0060	SANDRIGARDEN		cod. Saba 0162-00250
rif. orig.	531212711		rif. orig.	2007410	
modello	653		modello	GI50AL	
lunghezza tot.	562		lunghezza tot.	495	
Ø puleggia	54		Ø puleggia	70	
lung. lato corto	160		lung. lato corto	103	
lung. lato lungo	315		lung. lato lungo	311	
SANDRIGARDEN		cod. Saba 0162-00252			
rif. orig.	280000				
modello	LDV, MP				
lunghezza tot.	510				
Ø puleggia	70				
lung. lato corto	94				
lung. lato lungo	322				

CARDANI

HONDA		cod. Saba 2837-76840
rif. orig.	22100-VB3-803, 22100-VB5-805	
modello	HR214, HR216, HR2160, HRA536HX	

KIT CHIAVETTE PER SELETTORI MARCE

PEERLESS

cod. Saba **0162-30500**

rif. orig. 792089B
lunghezza mm 71,5



PEERLESS

cod. Saba **0162-30502**

rif. orig. 792160A
lunghezza mm 87



PEERLESS

cod. Saba **0162-30504**

rif. orig. 792180A
lunghezza mm 103



KIT CEPPI FRENO CAMBIO

UNIVERSALE

cod. Saba **0161-00489**

spessore mm 7-14
Ø mm 28
lunghezza mm -
larghezza mm -



UNIVERSALE

cod. Saba **1161-40366**

spessore mm 7-14
Ø mm 28
lunghezza mm -
larghezza mm -



UNIVERSALE

cod. Saba **0161-00490**

spessore mm -
Ø mm -
lunghezza mm 28,5
larghezza mm 12,7





G&W

**RICAMBI GENERICI, ANELLI TENUTA,
MARMITTE, MOLLE, TRAZIONI**

